

Pipelining and Exploiting Instruction-Level Parallelism (ILP)

- Pipelining and Instruction-Level Parallelism (ILP).
 - Definition of basic instruction block
 - Increasing Instruction-Level Parallelism (ILP) & Size of Basic Block:
 - Using Loop Unrolling Or exposing more ILP
 - MIPS Loop Unrolling Example. A Static Optimization Technique
 - Loop Unrolling Requirements.
 - Classification of Instruction Dependencies
 - Data dependencies
 - Name dependencies
 - Control dependencies
- ➔ Dependency Analysis
Dependency Graphs

**In Fourth Edition: Chapter 2.1, 2.2
(In Third Edition: Chapter 3.1, 4.1)**

Pipeline Hazard Condition = Dependency Violation

Static = At compilation time

Dynamic = At run time

EECC551 - Shaaban

#1 Winter 2010 lec#3 12-6-2010

Pipelining and Exploiting Instruction-Level Parallelism (ILP)

- **Instruction-Level Parallelism (ILP) exists when instructions in a sequence are independent and thus can be executed in parallel by overlapping.**
 - **Pipelining increases performance by overlapping the execution of independent instructions and thus exploits ILP in the code.**

↙ i.e instruction throughput (without stalling)
- **Preventing instruction dependency violations (hazards) may result in stall cycles in a pipelined CPU increasing its CPI (reducing performance).**
 - **The CPI of a real-life pipeline is given by (assuming ideal memory):**

i.e non-ideal

$$\text{Pipeline CPI} = \text{Ideal Pipeline CPI} + \text{Structural Stalls} + \text{RAW Stalls} + \text{WAR Stalls} + \text{WAW Stalls} + \text{Control Stalls}$$

- **Programs that have more ILP (fewer dependencies) tend to perform better on pipelined CPUs.**
 - **More ILP mean fewer instruction dependencies and thus fewer stall cycles needed to prevent instruction dependency violations** i.e hazards

Dependency Violation = Hazard

In Fourth Edition Chapter 2.1
(In Third Edition Chapter 3.1)

$$T = I \times \text{CPI} \times C$$

EECC551 - Shaaban

Instruction-Level Parallelism (ILP) Example

Given the following two code sequences with three instructions each:

Higher ILP	Program Order ↓	1	ADD.D	F2, F4, F6
		2	ADD.D	F10, F6, F8
		3	ADD.D	F12, F12, F14

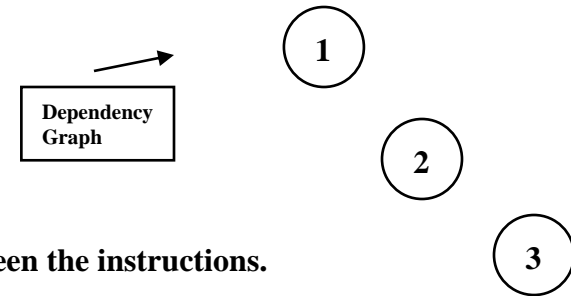

The instructions in the first code sequence above have no dependencies between the instructions. Thus the three instructions are said to be independent and can be executed in parallel or in any order (re-ordered). This code sequence is said to have a high degree of ILP.

Independent or parallel instructions. (no dependencies exist): High ILP

Lower ILP	Program Order ↓	1	ADD.D	F2, F4, F6	
		2	ADD.D	F10, F2, F8	← stalls
		3	ADD.D	F12, F10, F2	← stalls

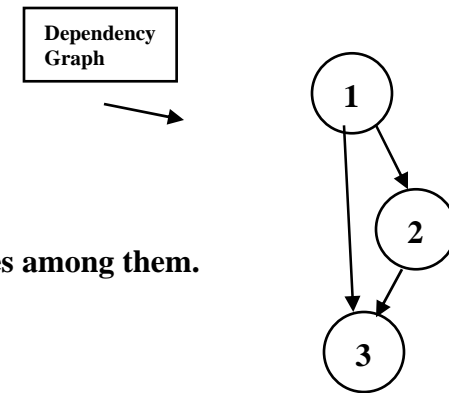

The instructions in the second code sequence above have three data dependencies among them. Instruction 2 depends on instruction 1. Instruction 3 depends on both instructions 1 and 2.

Thus the instructions in the sequence are not independent and cannot be executed in parallel. Thus the three instructions are said to be dependent and thus can be executed in parallel and their order cannot be changed with causing incorrect execution.

This code sequence is said to have a lower degree of ILP.

Dependent instructions (three dependencies exist): Lower ILP

More on dependency analysis and dependency graphs later in the lecture

EECC551 - Shaaban

Basic Instruction Block

- A basic instruction block is a straight-line code sequence with no branches in, except at the entry point, and no branches out except at the exit point of the sequence.

– Example: Body of a loop.

End of Basic Block

Start of Basic Block

Branch In

Basic Block

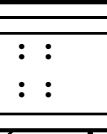

Branch (out)

- The amount of instruction-level parallelism (ILP) in a basic block is limited by instruction dependence present and size of the basic block. 1 2
- In typical integer code, dynamic branch frequency is about 15% (resulting average basic block size of about 7 instructions).
- Any static technique that increases the average size of basic blocks which increases the amount of exposed ILP in the code and provide more instructions for static pipeline scheduling by the compiler possibly eliminating more stall cycles and thus improves pipelined CPU performance.
 - Loop unrolling is one such technique that we examine next

Basic Blocks/Dynamic Execution Sequence (Trace) Example

Static Program

Order

A
B
D
H
⋮
E
J
⋮
I
⋮
K
⋮
C
F
L
⋮
G
N
⋮
M
⋮
O

- A-O = Basic Blocks terminating with conditional branches
- The outcomes of branches determine the basic block dynamic execution sequence or trace

Trace: Dynamic Sequence of basic blocks executed

Program Control Flow Graph (CFG)

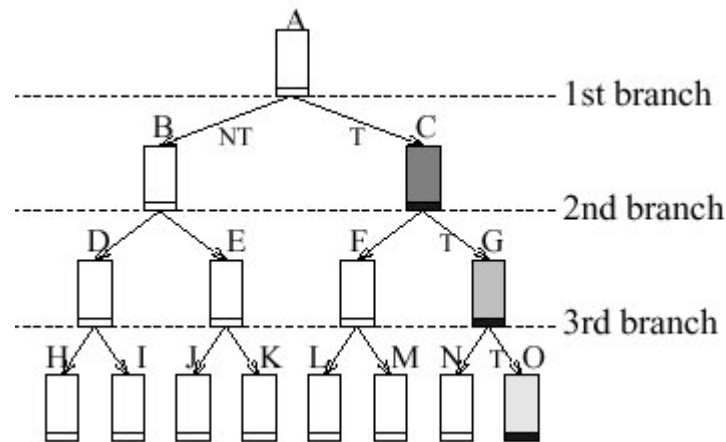

If all three branches are taken the execution trace will be basic blocks: ACGO

NT = Branch Not Taken
T = Branch Taken

Type of branches in this example:
“If-Then-Else” branches (not loops)

Average Basic Block Size = 5-7 instructions

EECC551 - Shaaban

Increasing Instruction-Level Parallelism (ILP)

- A common way to increase parallelism among instructions is to exploit parallelism among iterations of a loop i.e independent or parallel loop iterations
 - (i.e Loop Level Parallelism, LLP). Or Data Parallelism in a loop
- This is accomplished by **unrolling the loop** either statically by the compiler, or dynamically by hardware, which increases the size of the basic block present. This resulting larger basic block provides more instructions that can be scheduled or re-ordered by the compiler to eliminate more stall cycles.
- In this loop every iteration can overlap with any other iteration. Overlap within each iteration is minimal.

Example:

```
for (i=1; i<=1000; i=i+1;)
```

Independent (parallel) loop iterations:
A result of high degree of data parallelism

```
  x[i] = x[i] + y[i];
```

4 vector instructions:

```
Load Vector X  
Load Vector Y  
Add Vector X, X, Y  
Store Vector X
```

- In vector machines, utilizing vector instructions is an important alternative to exploit loop-level parallelism,
- Vector instructions operate on a number of data items. The above loop would require just four such instructions.
(potentially)

EECC551 - Shaaban

MIPS Loop Unrolling Example

- For the loop:

Note:
Independent
Loop Iterations

```
for (i=1000; i>0; i=i-1)
    x[i] = x[i] + s;
```

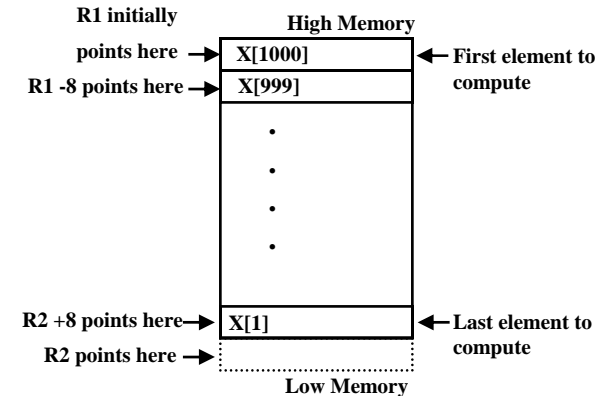

The straightforward MIPS assembly code is given by:

Program Order
↓

Loop: L.D	F0, 0 (R1)	;F0=array element	S
ADD.D	F4, F0, F2	;add scalar in F2 (constant)	
S.D	F4, 0(R1)	;store result	
DADDUI	R1, R1, #-8	;decrement pointer 8 bytes	
BNE	R1, R2, Loop	;branch R1!=R2	

$R1$ is initially the address of the element with highest address.
 $8(R2)$ is the address of the last element to operate on.

Basic block size = 5 instructions

$X[]$ array of double-precision floating-point numbers (8-bytes each)

In Fourth Edition Chapter 2.2
 (In Third Edition Chapter 4.1)

Initial value of $R1 = R2 + 8000$

EECC551 - Shaaban

#7 Winter 2010 lec#3 12-6-2010

MIPS FP Latency Assumptions Used In Chapter 2.2

For Loop Unrolling Example

3rd Edition in 4.1

- All FP units assumed to be pipelined.
- The following FP operations latencies are used:

(or Number of
Stall Cycles)

i.e followed immediately by ..
→

i.e 4 execution
(EX) cycles for
FP instructions

Instruction Producing Result	Instruction Using Result	Latency In Clock Cycles
FP ALU Op	→ Another FP ALU Op	3
FP ALU Op	Store Double	2
Load Double	FP ALU Op	1
Load Double	Store Double	0

- Other Assumptions:
- Branch resolved in decode stage, Branch penalty = 1 cycle
 - Full forwarding is used
 - Single Branch delay Slot
 - Potential structural hazards ignored

EECC551 - Shaaban

In Fourth Edition Chapter 2.2 (In Third Edition Chapter 4.1)

#8 Winter 2010 lec#3 12-6-2010

Loop Unrolling Example (continued)

- This loop code is executed on the MIPS pipeline as follows:
(Branch resolved in decode stage, Branch penalty = 1 cycle, Full forwarding is used)

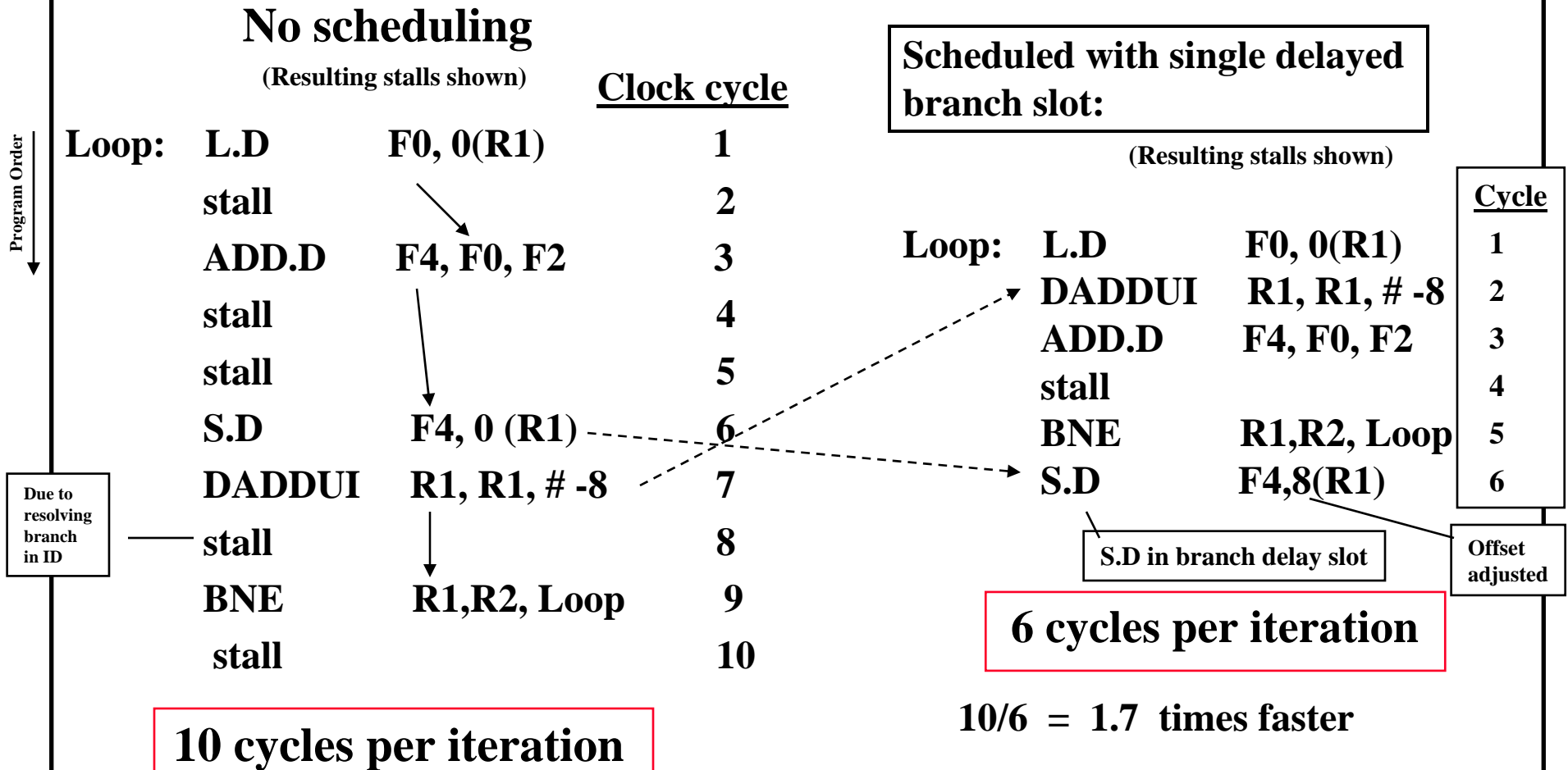

Loop Unrolling Example (continued)

Loop unrolled 4 times

New Basic Block Size = 14 Instructions

- The resulting loop code when four copies of the loop body are unrolled without reuse of registers.
- The size of the basic block increased from 5 instructions in the original loop to 14 instructions.

Register Renaming Used

Three branches and three decrements of R1 are eliminated.

Load and store addresses are changed to allow DADDUI instructions to be merged.

Performance:

The unrolled loop runs in 28 cycles assuming each L.D has 1 stall cycle, each ADD.D has 2 stall cycles, the DADDUI 1 stall, the branch 1 stall cycle, or $28/4 = 7$ cycles to produce each of the four elements.

i.e 7 cycles for each original iteration

(Resulting stalls shown)

Iteration	Cycle	Instruction	Notes
1	1	Loop:1 L.D F0, 0(R1)	
	2	Stall	
	3	ADD.D F4, F0, F2	
	4	Stall	
	5	Stall	
	6	SD F4,0 (R1)	; drop DADDUI & BNE
2	7	LD F6, -8(R1)	
	8	Stall	
	9	ADDD F8, F6, F2	
	10	Stall	
	11	Stall	
	12	SD F8, -8 (R1),	; drop DADDUI & BNE
3	13	LD F10, -16(R1)	
	14	Stall	
	15	ADDD F12, F10, F2	
	16	Stall	
	17	Stall	
	18	SD F12, -16 (R1)	; drop DADDUI & BNE
4	19	LD F14, -24 (R1)	
	20	Stall	
	21	ADDD F16, F14, F2	
	22	Stall	
	23	Stall	
	24	SD F16, -24(R1)	
	25	DADDUI R1, R1, # -32	
	26	Stall	
	27	BNE R1, R2, Loop	
	28	Stall	

In Fourth Edition Chapter 2.2
(In Third Edition Chapter 4.1)

i.e. unrolled four times

Note use of different registers for each iteration (register renaming)

EECC551 - Shaaban

Loop Unrolling Example (continued)

Note: No stalls

When scheduled for pipeline

Basic Block size = 14 instructions vs. 5 (no unrolling)

The execution time of the loop has dropped to 14 cycles, or $14/4 = 3.5$ clock cycles per element

i.e 3.5 cycles for each original iteration

compared to 7 before scheduling and 6 when scheduled but unrolled.

$$\text{Speedup} = 6/3.5 = 1.7$$

i.e more ILP exposed

Unrolling the loop exposed more computations that can be scheduled to minimize stalls by increasing the size of the basic block from 5 instructions in the original loop to 14 instructions in the unrolled loop.

Larger Basic Block \longrightarrow More ILP

Exposed

Offset = $16 - 32 = -16$

Program Order \downarrow

```

Loop:  L.D      F0, 0(R1)
        L.D      F6,-8 (R1)
        L.D      F10,-16(R1)
        L.D      F14,-24(R1)
        ADD.D    F4, F0, F2
        ADD.D    F8, F6, F2
        ADD.D    F12, F10, F2
        ADD.D    F16, F14, F2
        S.D      F4, 0(R1)
        S.D      F8, -8(R1)
        DADDUI   R1, R1,# -32
        S.D      F12, 16(R1),F12
        BNE     R1,R2, Loop
        S.D      F16, 8(R1), F16 ;8-32 = -24
    
```

In Fourth Edition Chapter 2.2
(In Third Edition Chapter 4.1)

In branch delay slot

EECC551 - Shaaban

Loop Unrolling Benefits & Requirements

- Loop unrolling improves performance in two ways:

1 – Larger basic block size: More instructions to schedule and thus possibly more stall cycles are eliminated. More ILP exposed due to larger basic block

2 – Fewer instructions executed: Fewer branches and loop maintenance instructions executed

- From the loop unrolling example, the following guidelines where followed:

- Determine that unrolling the loop would be useful by finding that the loop iterations where independent.
- Determine that it was legal to move S.D after DADDUI and BNE; find the correct S.D offset.
- Use different registers (rename registers) to avoid constraints of using the same registers (**WAR, WAW**). More registers are needed.
- Eliminate extra tests and branches and adjust loop maintenance code.
- Determine that loads and stores can be interchanged by observing that they are independent from different loops.
- Schedule the code, preserving any dependencies needed to give the same result as the original code.

Instruction Dependencies

- Determining instruction dependencies (dependency analysis) is important for pipeline scheduling and to determine the amount of instruction level parallelism (ILP) in the program to be exploited.
- Instruction Dependency Graph: A directed graph where graph nodes represent instructions and graph edges represent instruction dependencies.
- If two instructions are independent or parallel (no dependencies between them exist), they can be executed simultaneously in the pipeline without causing stalls (no pipeline hazards); assuming the pipeline has sufficient resources (no hardware hazards).
- Instructions that are dependent are not parallel and cannot be reordered by the compiler or hardware.
- Instruction dependencies are classified as:

- **Data dependencies**
(or Flow)
- **Name dependencies**
(two types: anti-dependence and write dependence)
- **Control dependencies**

Otherwise incorrect execution results

Pipeline Hazard = Dependency Violation

Name: Register Name
or Named Memory Location

In Fourth Edition Chapter 2.1 (In Third Edition Chapter 3.1)

EECC551 - Shaaban

(True) Data Dependence

AKA Data Flow Dependence

- Instruction i precedes instruction j in the program sequence or order
- Instruction i produces a result used by instruction j , $i \rightarrow j$
 - Then instruction j is said to be data dependent on instruction i
- Changing the relative execution order of i, j violates this data dependence and results in a **RAW** hazard and incorrect execution.

Also called: Data Flow Dependence or just Flow Dependence

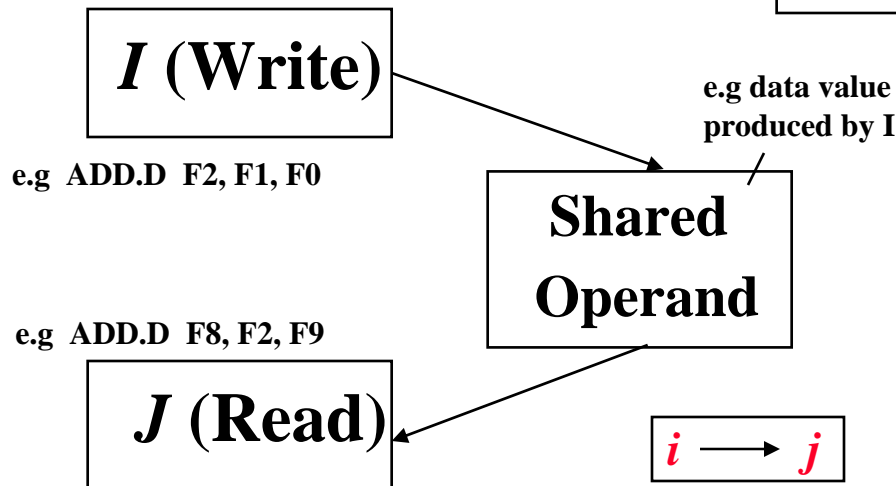

Dependency Graph Representation

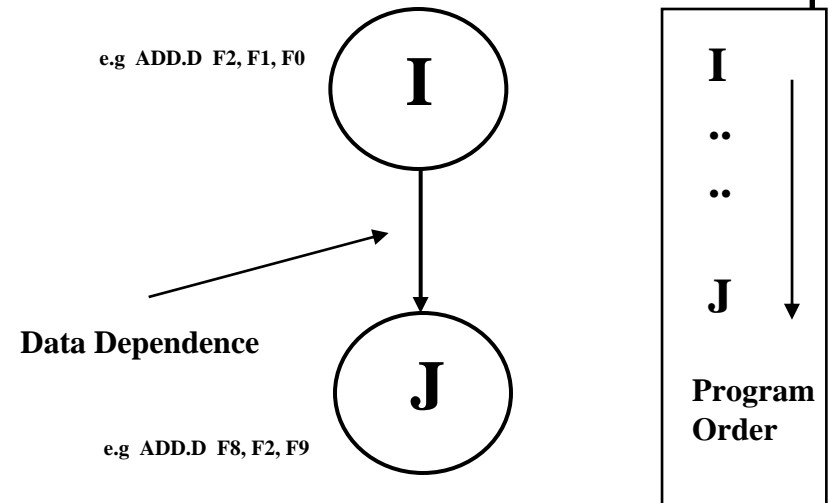

J data dependent on I resulting in a Read after Write (RAW) hazard if their relative execution order is changed

i.e. Data dependence violation = RAW Hazard

i.e. A data dependence is violated

i.e. relative order of write by I and read by J

EECC551 - Shaaban

Instruction Data Dependencies

(or Flow)

Given two instructions i, j where i precedes j in program order:

- Instruction j is data dependent on instruction i if:

Data Dependence Chain

- Instruction i produces a result used by instruction j , resulting in a direct **RAW** hazard if their order is not maintained, or
- Instruction j is data dependent on instruction k and instruction k is data dependent on instruction i which implies a chain of **data dependencies** between the instructions.

Example

Example: The arrows indicate data dependencies and point to the dependent instruction which must follow and remain in the original instruction order to ensure correct execution.

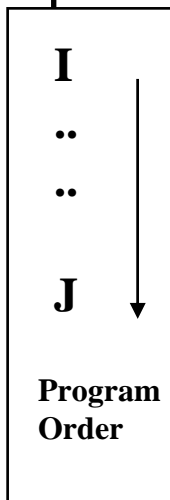

i	1	L.D	F0, 0 (R1)	; F0=array element
k	2	ADD.D	F4, F0, F2	; add scalar in F2
j	3	S.D	F4,0 (R1)	; store result

Dependency Graph

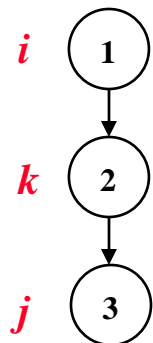

In Fourth Edition Chapter 2.1 (In Third Edition Chapter 3.1)

EECC551 - Shaaban

Instruction Name Dependencies

- A name dependence occurs when two instructions use (share) the same register or memory location, called a name.
- No flow of data exist between the instructions involved in the name dependency (i.e. no producer/consumer relationship)
- If instruction i precedes instruction j in program order then two types of name dependencies can exist:

The Two Types of Name Dependence:

- An anti-dependence exists when j writes to the same register or memory location that instruction i reads
 - Anti-dependence violation: Relative read/write order is changed
 - This results in a **WAR** hazard and thus the relative instruction read/write and execution order must preserved.
- An output or (write) dependence exists when instruction i and j write to the same register or memory location (i.e the same name)
 - Output-dependence violation: Relative write order is changed
 - This results in a **WAW** hazard and thus instruction write and execution order must be preserved

I
..
..
J
↓
Program Order

In Fourth Edition Chapter 2.1
(In Third Edition Chapter 3.1)

Name: Register or Memory Location

EECC551 - Shaaban

#16 Winter 2010 lec#3 12-6-2010

Name Dependence Classification: Anti-Dependence

- Instruction *i* precedes instruction *j* in the program sequence or order $I \rightarrow J$
- Instruction *i* reads a value from a name (register or memory location)
- Instruction *j* writes a value to the same name (same register or memory location read by i)
 - Then instruction *j* is said to be anti-dependent on instruction *i*
- Changing the relative execution order of *i*, *j* violates this name dependence and results in a **WAR** hazard and incorrect execution.
- This name dependence can be eliminated by “renaming” the shared name.

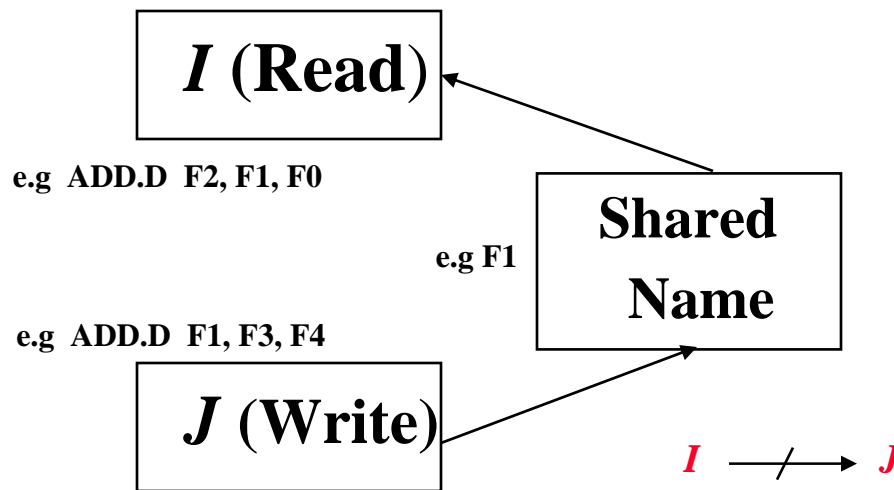

J is anti-dependent on I resulting in a Write after Read (WAR) hazard if their relative execution order is changed

Dependency Graph Representation

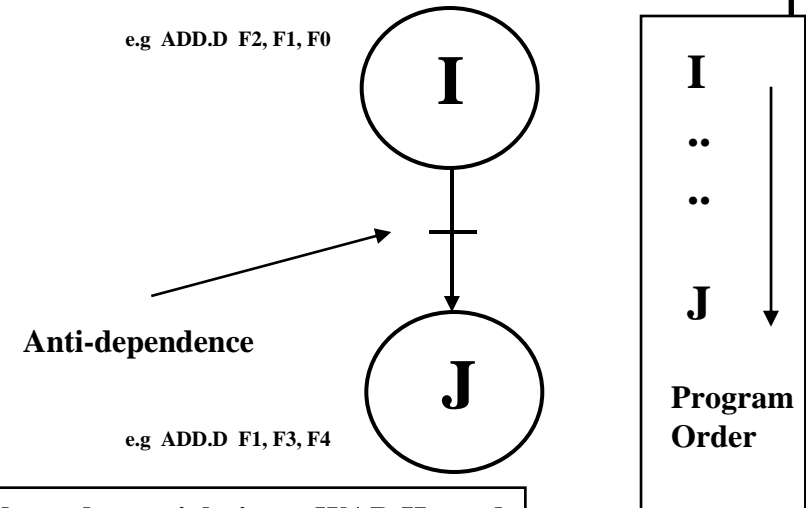

i.e Anti-dependence violation = WAR Hazard

i.e relative order of read by I and write by J

Name: Register or Memory Location

EECC551 - Shaaban

Name Dependence Classification:

Output (or Write) Dependence

$I \rightarrow \ominus \rightarrow J$

- Instruction i precedes instruction j in the program sequence or order
- Both instructions i, j write to the same name (same register or memory location)
 - Then instruction j is said to be output-dependent on instruction i
- Changing the relative execution order of i, j violates this name dependence and results in a **WAW** hazard and incorrect execution.
- This name dependence can also be eliminated by “renaming” the shared name.

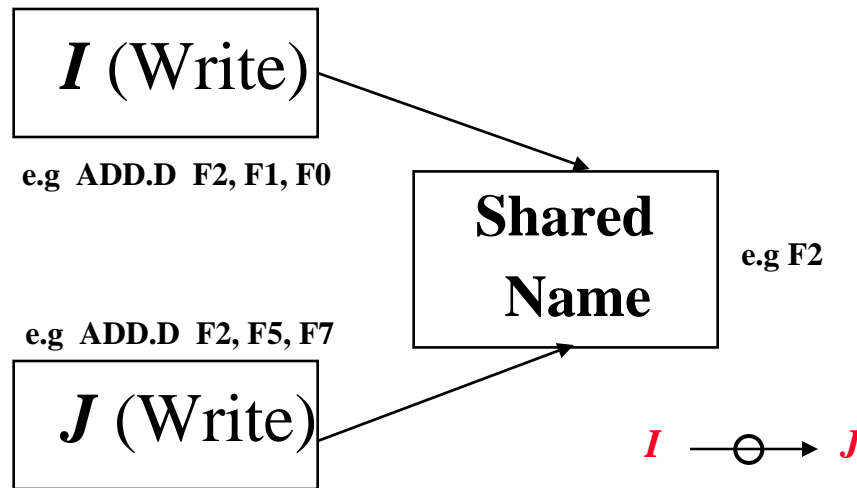

Dependency Graph Representation

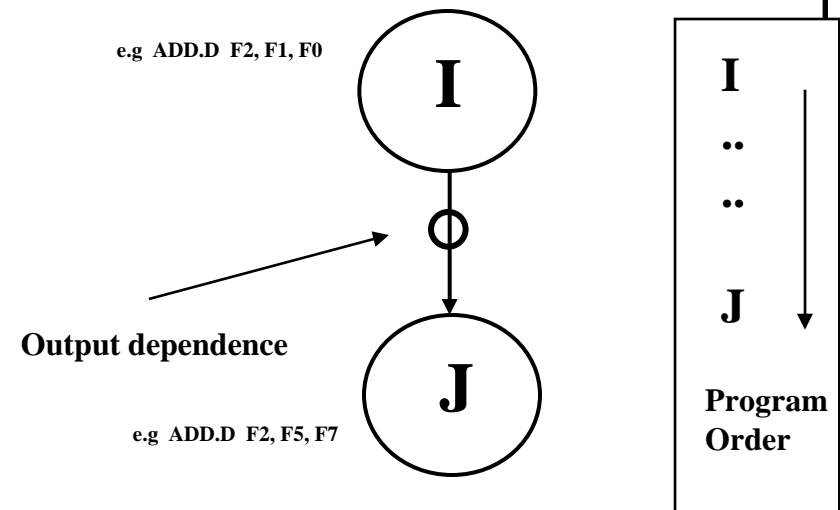

J is output-dependent on I resulting a Write after Write (WAW) hazard if their relative execution order is changed

i.e. Output-dependence violation = WAW Hazard

i.e. relative order of write by I and write by J

EECC551 - Shaaban

Name: Register or Memory Location

Instruction Dependence Example

- For the following code identify all data and name dependence between instructions and give the dependency graph

Program Order ↓	1	L.D	F0, 0 (R1)
	2	ADD.D	F4, F0, F2
	3	S.D	F4, 0(R1)
	4	L.D	F0, -8(R1)
	5	ADD.D	F4, F0, F2
	6	S.D	F4, -8(R1)

True Data Dependence:

Instruction 2 depends on instruction 1 (instruction 1 result in F0 used by instruction 2), Similarly, instructions (4,5)

Instruction 3 depends on instruction 2 (instruction 2 result in F4 used by instruction 3) Similarly, instructions (5,6)

Name Dependence:

Output Name Dependence (WAW):

Instruction 1 has an output name dependence (WAW) over result register (name) F0 with instructions 4

Instruction 2 has an output name dependence (WAW) over result register (name) F4 with instructions 5

Anti-dependence (WAR):

Instruction 2 has an anti-dependence with instruction 4 over register (name) F0 which is an operand of instruction 1 and the result of instruction 4

Instruction 3 has an anti-dependence with instruction 5 over register (name) F4 which is an operand of instruction 3 and the result of instruction 5

Instruction Dependence Example

Dependency Graph

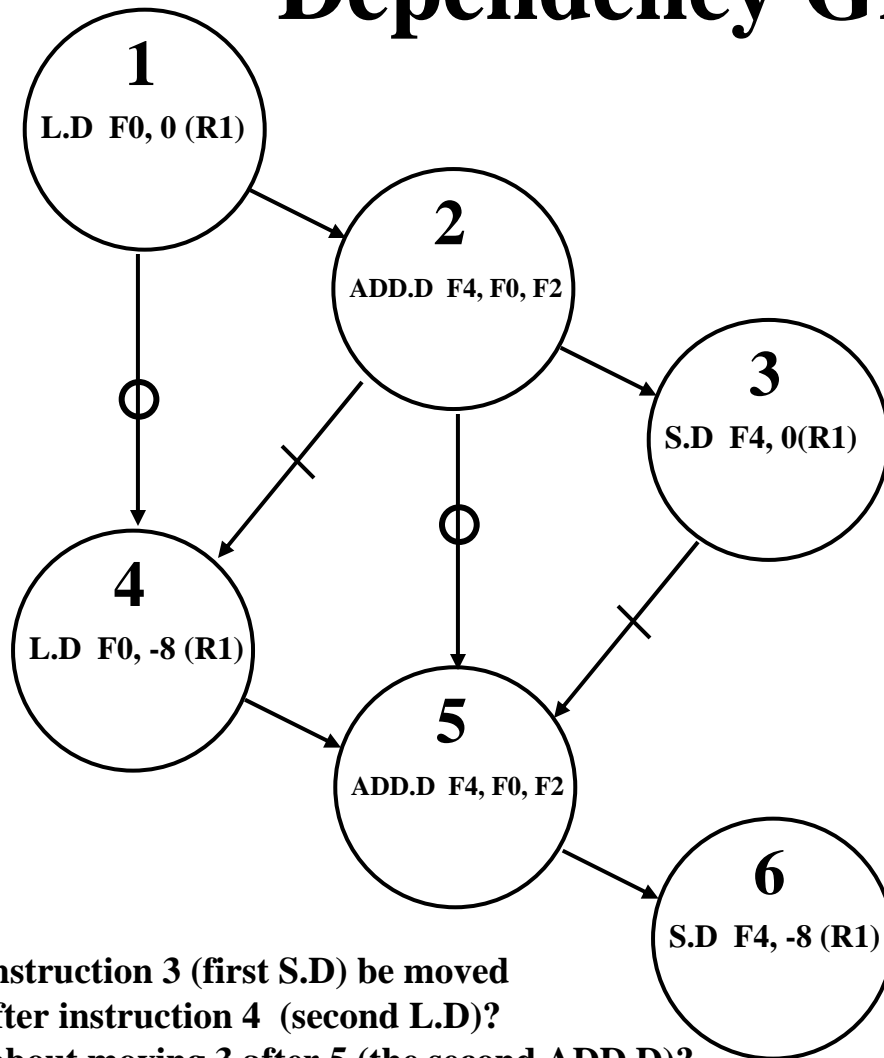

Program Order ↓

Example Code

```

1  L.D    F0, 0 (R1)
2  ADD.D  F4, F0, F2
3  S.D    F4, 0(R1)
4  L.D    F0, -8(R1)
5  ADD.D  F4, F0, F2
6  S.D    F4, -8(R1)
  
```

Date Dependence:

(1, 2) (2, 3) (4, 5) (5, 6)

Output Dependence:

(1, 4) (2, 5)

Anti-dependence:

(2, 4) (3, 5)

Can instruction 3 (first S.D) be moved just after instruction 4 (second L.D)?
How about moving 3 after 5 (the second ADD.D)?
If not what dependencies are violated?

Can instruction 4 (second L.D) be moved just after instruction 1 (first L.D)?
If not what dependencies are violated?

What happens if we rename F0 to F6 and F4 to F8 in instructions 4, 5, 6?

EECC551 - Shaaban

Instruction Dependence Example

No Register Renaming Done

In the unrolled loop, using the same registers results in name (green) and data tendencies (red)

Program Order ↓

1	Loop: L.D	F0, 0 (R1)
2	ADD.D	F4, F0, F2
3	S.D	F4, 0(R1)
4	L.D	F0, -8(R1)
5	ADD.D	F4, F0, F2
6	S.D	F4, -8(R1)
7	L.D	F0, -16(R1)
8	ADD.D	F4, F0, F2
9	S.D	F4, -16 (R1)
10	L.D	F0, -24 (R1)
11	ADD.D	F4, F0, F2
12	S.D	F4, -24(R1)
13	DADDUI	R1, R1, # -32
14	BNE	R1, R2, Loop

From The Code to the left:

True Data Dependence (RAW) Examples:

Instruction 2 ADD.D F4, F0, F2
depends on instruction 1 L.D F0, 0 (R1)
(instruction 1 result in F0 used by instruction 2)
Similarly, instructions (4,5) (7,8) (10,11)

Instruction 3 S.D F4, 0(R1)
depends on instruction 2 ADD.D F4, F0, F2
(instruction 2 result in F4 used by instruction 3)
Similarly, instructions (5,6) (8,9) (11,12)

Name Dependence (WAR, WAW) Examples

Output Name Dependence (WAW) Examples:

Instruction 1 L.D F0, 0 (R1)
has an output name dependence (WAW) over result register
(name) F0 with instructions 4, 7, 10

Anti-dependence (WAR) Examples:

Instruction 2 ADD.D F4, F0, F2
has an anti-dependence (WAR) with
instruction 4 L.D F0, 0 (R1)
over register (name) F0 which is an operand of instruction 1
and the result of instruction 4
Similarly, an anti-dependence (WAR) over F0 exists
between instructions (5, 7) (8, 10)

Name Dependence Removal

Using Register Renaming →

In the unrolled loop, using the same registers results in name (green) and data dependencies (red)

i.e no register renaming done

Program Order ↓

Loop: L.D	F0, 0 (R1)
ADD.D	F4, F0, F2
S.D	F4, 0(R1)
L.D	F0, -8(R1)
ADD.D	F4, F0, F2
S.D	F4, -8(R1)
L.D	F0, -16(R1)
ADD.D	F4, F0, F2
S.D	F4, -16 (R1)
L.D	F0, -24 (R1)
ADD.D	F4, F0, F2
S.D	F4, -24(R1)
DADDUI	R1, R1, # -32
BNE	R1, R2, Loop

Renaming the registers used for each copy of the loop body, only true data dependencies remain

(Name dependencies are eliminated):

Using register renaming

Loop: L.D	F0, 0(R1)
ADD.D	F4, F0, F2
S.D	F4, 0(R1)
L.D	F6, -8(R1)
ADD.D	F8, F6, F2
S.D	F8, -8 (R1)
L.D	F10, -16(R1)
ADD.D	F12, F10, F2
S.D	F12, -16 (R1)
L.D	F14, -24(R1)
ADD.D	F16, F14, F2
S.D	F16, -24(R1)
DADDUI	R1, R1, # -32
BNE	R1, R2, Loop

As was done in Loop unrolling example

In Fourth Edition Chapter 2.2
(In Third Edition Chapter 4.1)

As shown above, name dependencies can be eliminated by "renaming" the shared names (renaming registers in this case, requiring more ISA registers).

EECC551 - Shaaban

Control Dependencies

- Control dependence determines the ordering of an instruction with respect to a branch (control) instruction.
- Every instruction in a program except those in the very first basic block of the program is control dependent on some set of branches.

1. An instruction which is control dependent on a branch cannot be moved before the branch so that its execution is no longer controlled by the branch.
2. An instruction which is not control dependent on the branch cannot be moved so that its execution is controlled by the branch (in the then portion).
→ Both scenarios lead a control dependence violation (control hazard).

- It's possible in some cases to violate these constraints and still have correct execution.
- Example of control dependence in the then part of an if statement:

```
if p1 {  
    S1;  
};  
If p2 {  
    S2;  
}
```

Conditional branch

S1 is control dependent on p1

S2 is control dependent on p2 but not on p1

Conditional branch

What happens if S1 is moved here?

Control Dependence Example

The unrolled loop code with the intermediate branches still in place is shown here. →

Branch conditions are complemented here (BEQ instead of BNE, except last one) to allow the fall-through to execute another loop.

BEQ instructions prevent the overlapping of iterations for scheduling optimizations.

(4 basic blocks B0-B3 each 5 instructions)

Due to control dependencies

Moving the instructions requires a change in the control dependencies present.

Removing the intermediate branches changes (removes) the internal control dependencies present increasing basic block size (to 14) and makes more optimizations (reordering) possible.

As seen previously in the loop unrolling example

Loop:	L.D	F0, 0 (R1)
	ADD.D	F4, F0, F2
B0	S.D	F4,0 (R1)
	DADDUI	R1, R1, #-8
	BEQ	R1, R2, exit
	L.D	F6, 0 (R1)
	ADD.D	F8, F6, F2
B1	S.D	F8, 0 (R1)
	DADDUI	R1, R1, #-8
	BEQ	R1, R2, exit
	L.D	F10, 0 (R1)
	ADD.D	F12, F10, F2
B2	S.D	F12,0 (R1)
	DADDUI	R1, R1, #-8
	BEQ	R1, R2,exit
	L.D	F14, 0 (R1)
	ADD.D	F16, F14, F2
B3	S.D	F16, 0 (R1)
	DADDUI	R1, R1, #-8
	BNE	R1, R2,Loop

exit:

B0 – B3: Basic blocks, 5 instructions each

EECC551 - Shaaban