

Point-to-Point Vs. Shared Channel Communication In LANs

- **Point-to-point:**

- Computers connected by communication channels that each connect exactly two computers with access to full channel bandwidth.
- Forms a mesh or point-to-point network.
- Allows flexibility in communication hardware, packet formats, etc.
- Provides security and privacy because communication channel is not shared.
- Number of channels grows as square of number of computers
for n computers: $(n^2 - n)/2$

- **Shared or Broadcast Channel:**

- All computers connected to a shared broadcast-based communication channel and share the channel bandwidth.
- Security issues as a result of broadcasting to all computers.
- Cost effective due to reduced number of channels and interface hardware components.

Ethernet

- **LANs developed in late 1960s and early 1970s.**
 - **Key idea: Reduce number of connections by sharing connections (communication channels) among computers.**
- **Ethernet is the most widely used LAN technology:**
 - **Invented at Xerox PARC (Palo Alto Research Center) in 1970s.**
- **Defined in a standard by Xerox, Intel and Digital - DIX standard.**
- **Standard is now managed by IEEE - defines formats, voltages, cable lengths, etc., IEEE 802.3:**
 - **10BASE-T: Standard Ethernet 10Mbps.**
 - **100-BASE-T: Fast Ethernet 100Mbps.**
 - **1000-BASE-T: Gigabit Ethernet 1000Mbps.**
- **One Ethernet cable is sometimes called a segment.**
 - **Limited to 500 meters in length for 10BASE-T.**
- **Uses:**
 - **Bus Topology: Single coax, cable forming a segment - the ether**
 - **Star Topology: Using hubs or switches (several segments).**

LAN Topologies

Bus (shared cable)

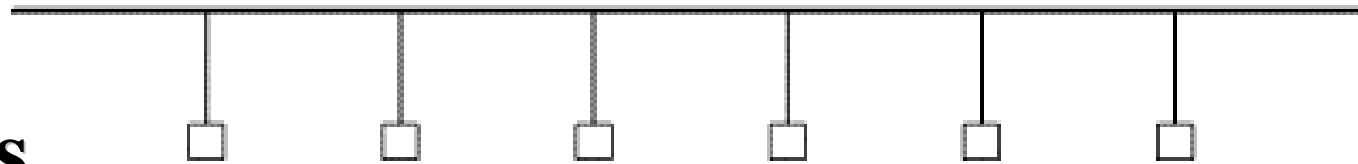

Bus

Requires fewer cables; may be disabled if cable is cut.

Star

Easier to manage and more robust than bus connection, requires more cables
Disabled if hub or switch is damaged.

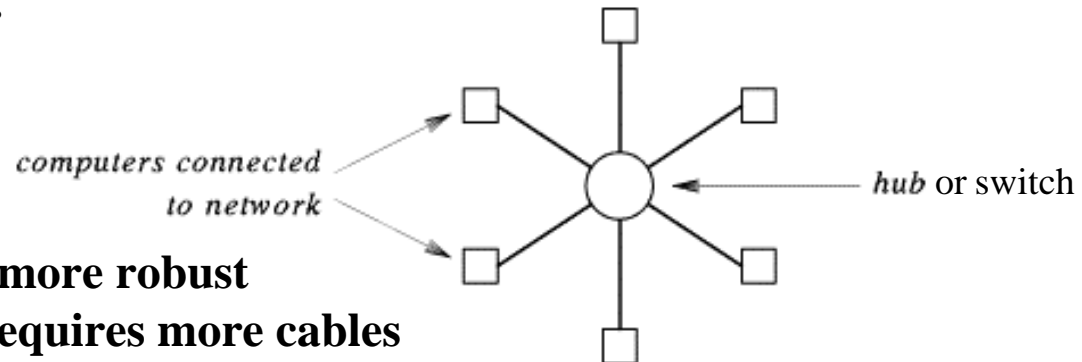

Ring

Ease of synchronization; may be disabled if any cable is cut.

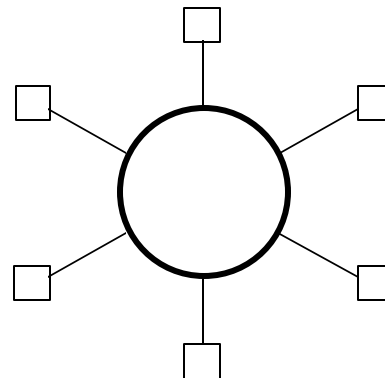

LAN hardware: Network Interface Hardware

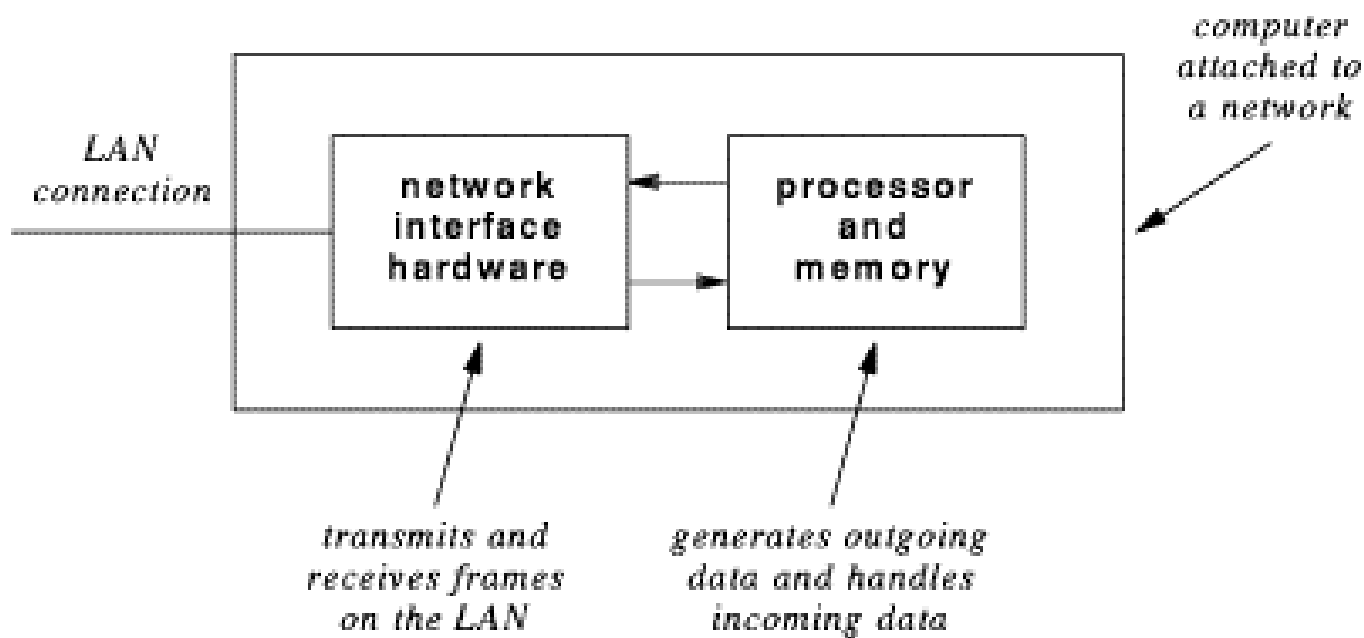

LAN Interface Hardware

- **LAN interface hardware or Network Interface Card (NIC), handles all details of frame transmission and reception:**
 - Adds hardware addresses, error detection codes, etc. to outgoing frames.
 - May use DMA to copy frame data directly from main memory.
 - Obeys access rules (e.g., CSMA/CD) when transmitting.
 - Checks error detection codes on incoming frames.
 - May use DMA to copy data directly into main memory.
 - Checks destination address on incoming frames.
- **If destination address on incoming frame matches the local station's address, a copy of the frame is passed to the attached computer.**
- **Frames not addressed to the local computer are ignored and don't affect the local computer in any way.**

IEEE Standard 802.3 (Ethernet)

- 1-persistent CSMA/CD LAN. 10-1000Mbps.
- Broadcast to several destinations possible using addresses with high-order bit = 1.
- Random number of waiting slots upon a collision is chosen by binary **exponential backoff algorithm**:
 - First collision: wait 0 or 1 slots.
 - After **i** collisions wait a random number of slots between **0** and **$2^i - 1$** with a maximum of 1023.
 - After 16 collisions, failure is reported to higher layers.
- Simplified Channel efficiency = **$P / (P + 2\tau/A)$** where:
 - **$A = kp(1-p)^{k-1}$** **k** stations each with **p** probability to transmit in a contention slot.
 - **P** time to transmit a frame.
 - **τ** worst case propagation delay.

Coaxial Cable Bus Ethernet Connection

Thick Coaxial Cable 10BASE-5

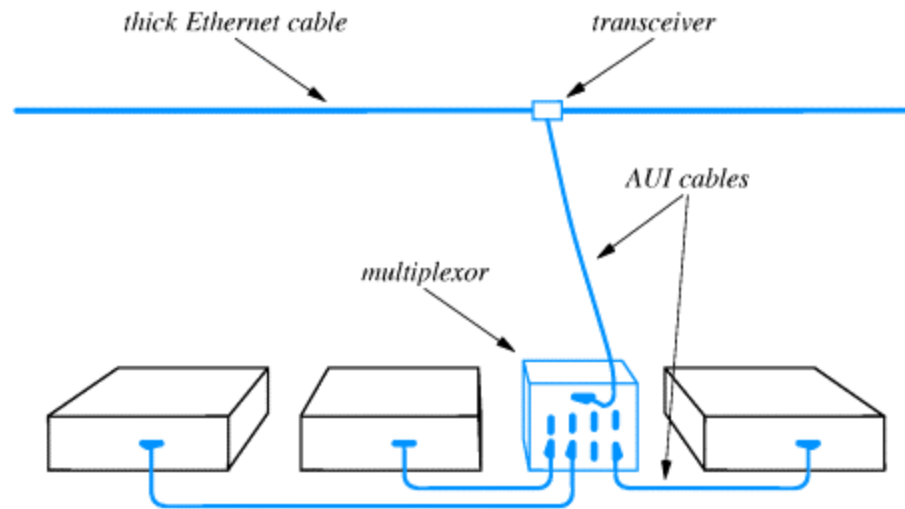

Thin Coaxial Cable 10BASE-2

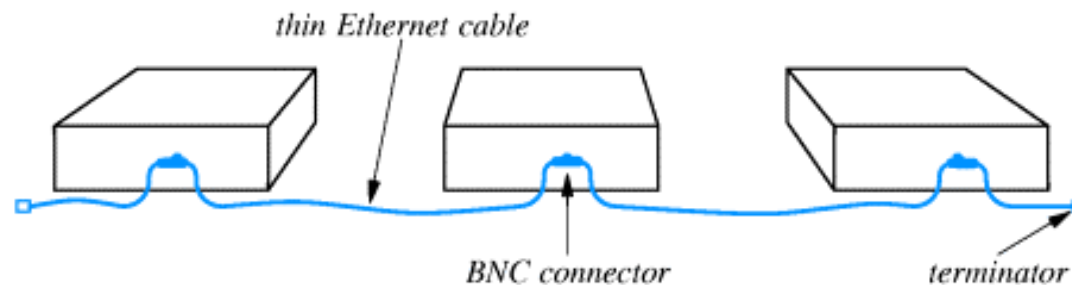

Twisted-Pair Star Ethernet 10-100BASE-T Connection

A hub or a switch forms the center of the star.

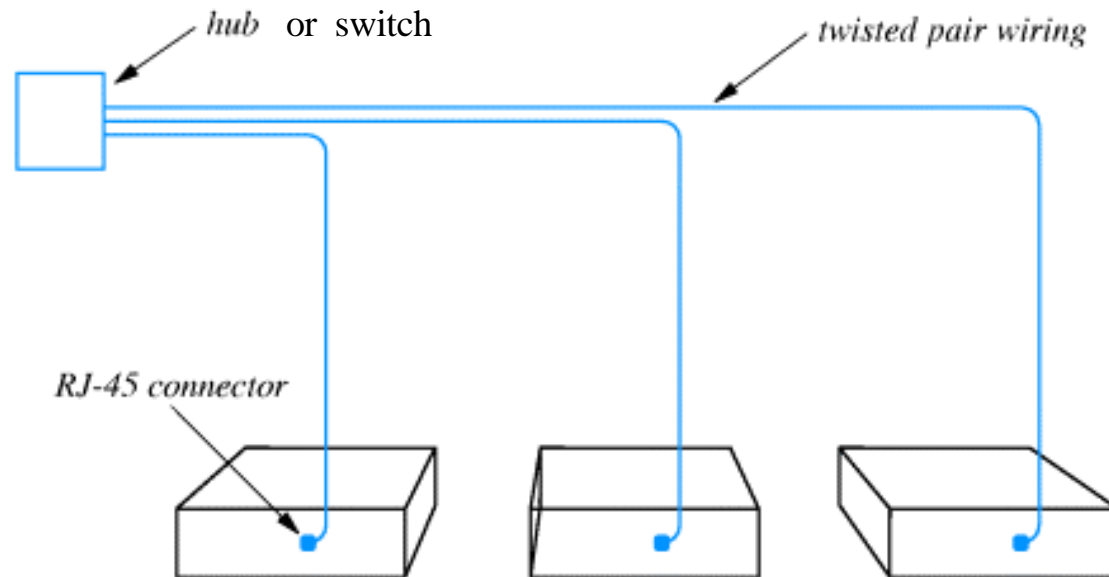

When a switch is used:

- Every computer on the LAN is connected to its own Ethernet segment.
- No frame collisions: Frames directed by the switch to destination.**
- Every computer has access to full bandwidth (10 or 100Mbps).

IEEE STANDARD 802.3 For LANS/MANS

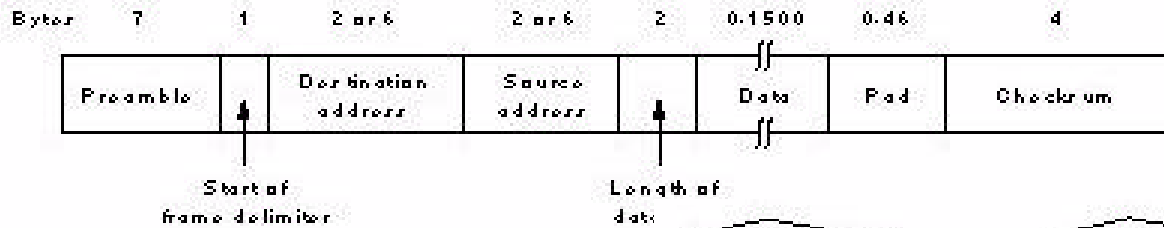

802.3 Frame Format

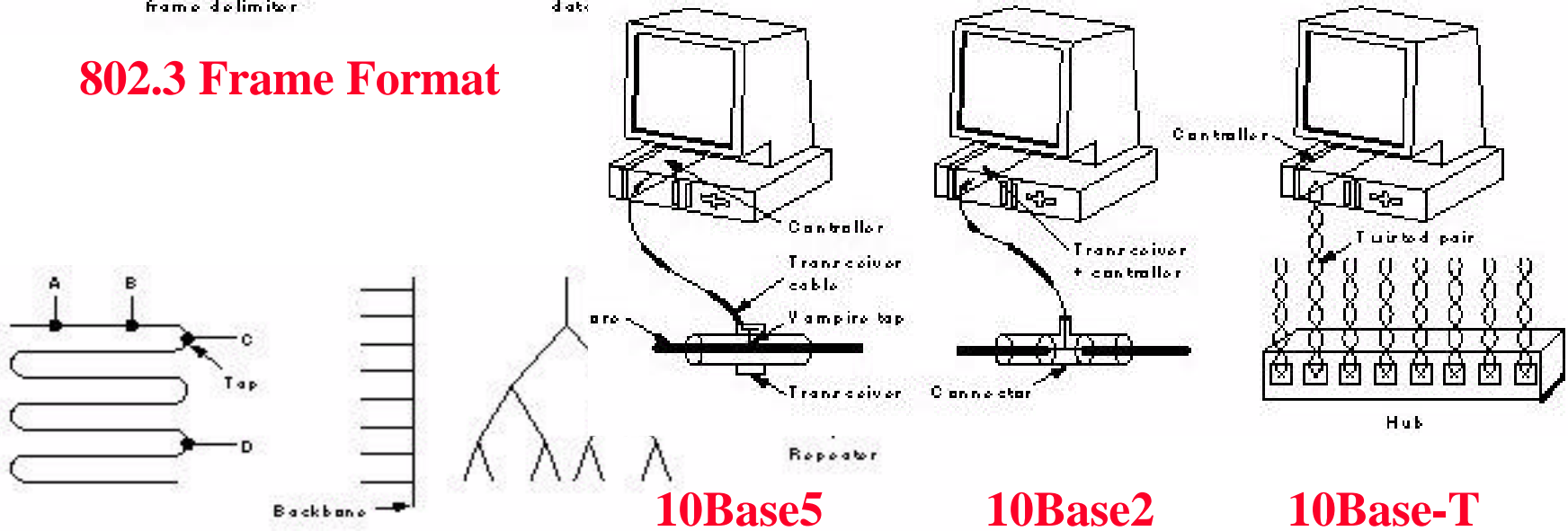

Name	Cable	Max. segment	Nodes/seg.	Advantages
10Base5	Thick coax	500 m	100	Good for backbones
10Base2	Thin coax	200 m	30	Cheapest system
10Base-T	Twisted pair	100 m	1024	Easy maintenance
10Base-F	Fiber optics	2000 m	1024	Best between buildings

Collision Detection Delay in Ethernet, CSMA/CD

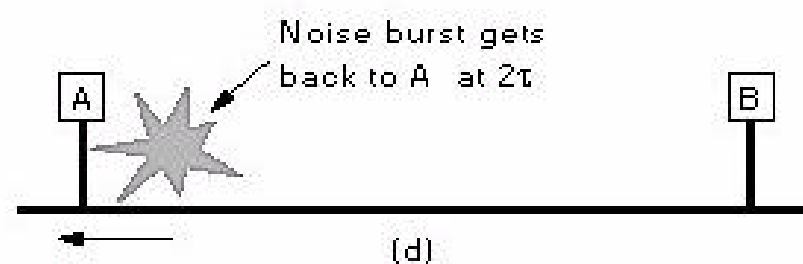
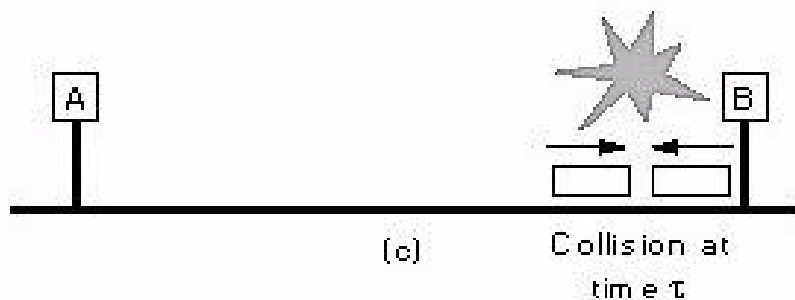
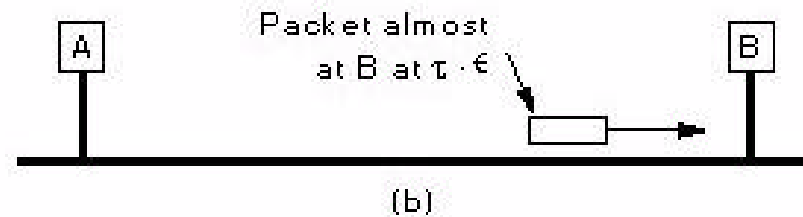
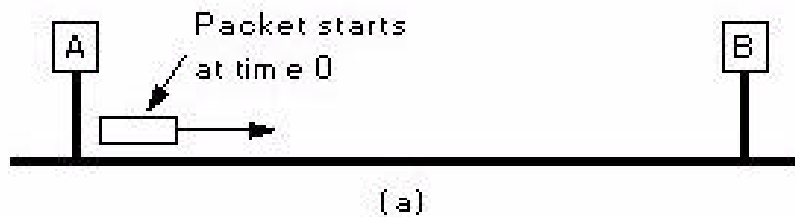

As a result, the time to transmit a frame on the media must be longer than 2τ otherwise collisions will be undetectable to some stations. This determines the minimum allowed frame size.

IEEE STANDARD 802.3 10BASE-T LAN/MAN Bit Encoding

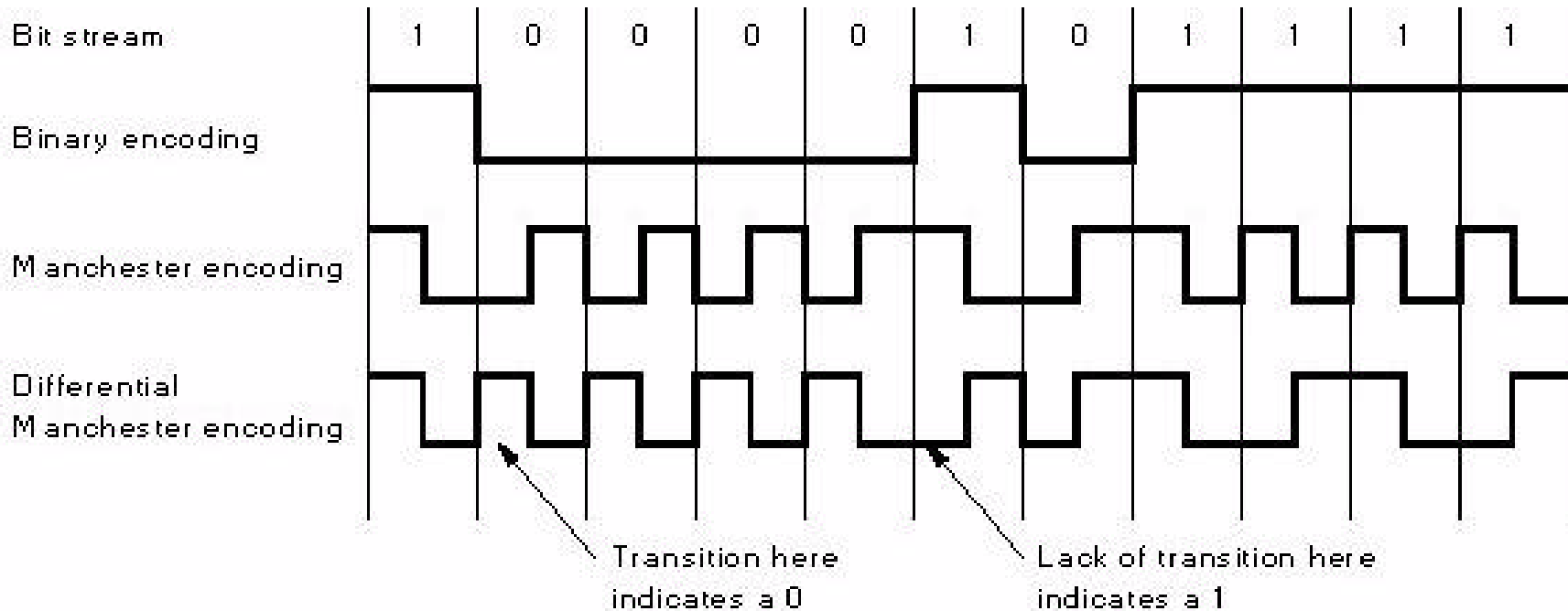

- **Encoding ensures that the start, middle, end of each bit is known without using an external clock.**
- **Aids in collision detection.**
- **Requires twice the amount of bandwidth of straight binary encoding.**
- **High signal = .85 volts, low signal = -.85 volts**

The 802.3 (Ethernet) Frame Format

- Preamble: 7 bytes 10101010 to synchronize station clocks.
- Start of frame byte: 10101011
- Destination address.
- Source address.
- Length of data field.
- Data: 0-1500 bytes.
- Pad: padding bits to make frame size more than the minimum size (~64 bits)
- Checksum: 4 bytes (CRC-32).

Minimum frame size:
The time to transmit a frame on the media must be longer than 2τ otherwise collisions will be undetectable to some stations.

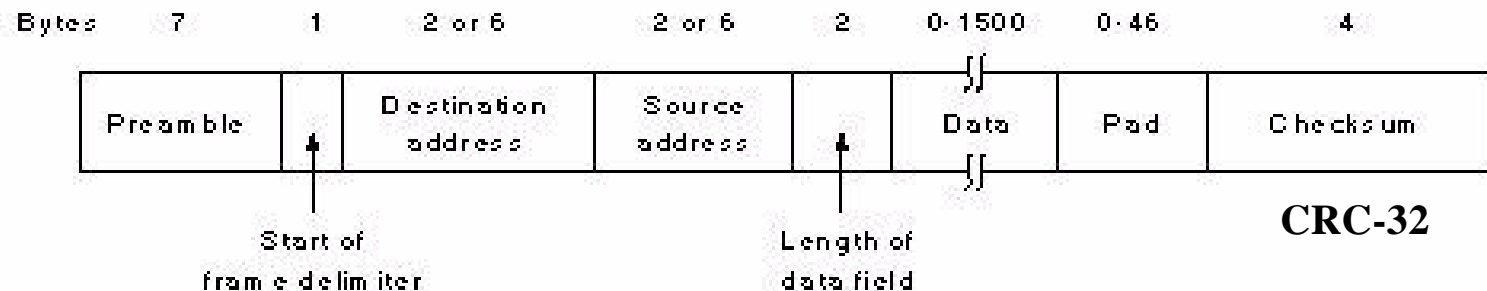

Efficiency of 802.3 Ethernet at 10 Mbps With 512 Bit Contention Slot Time

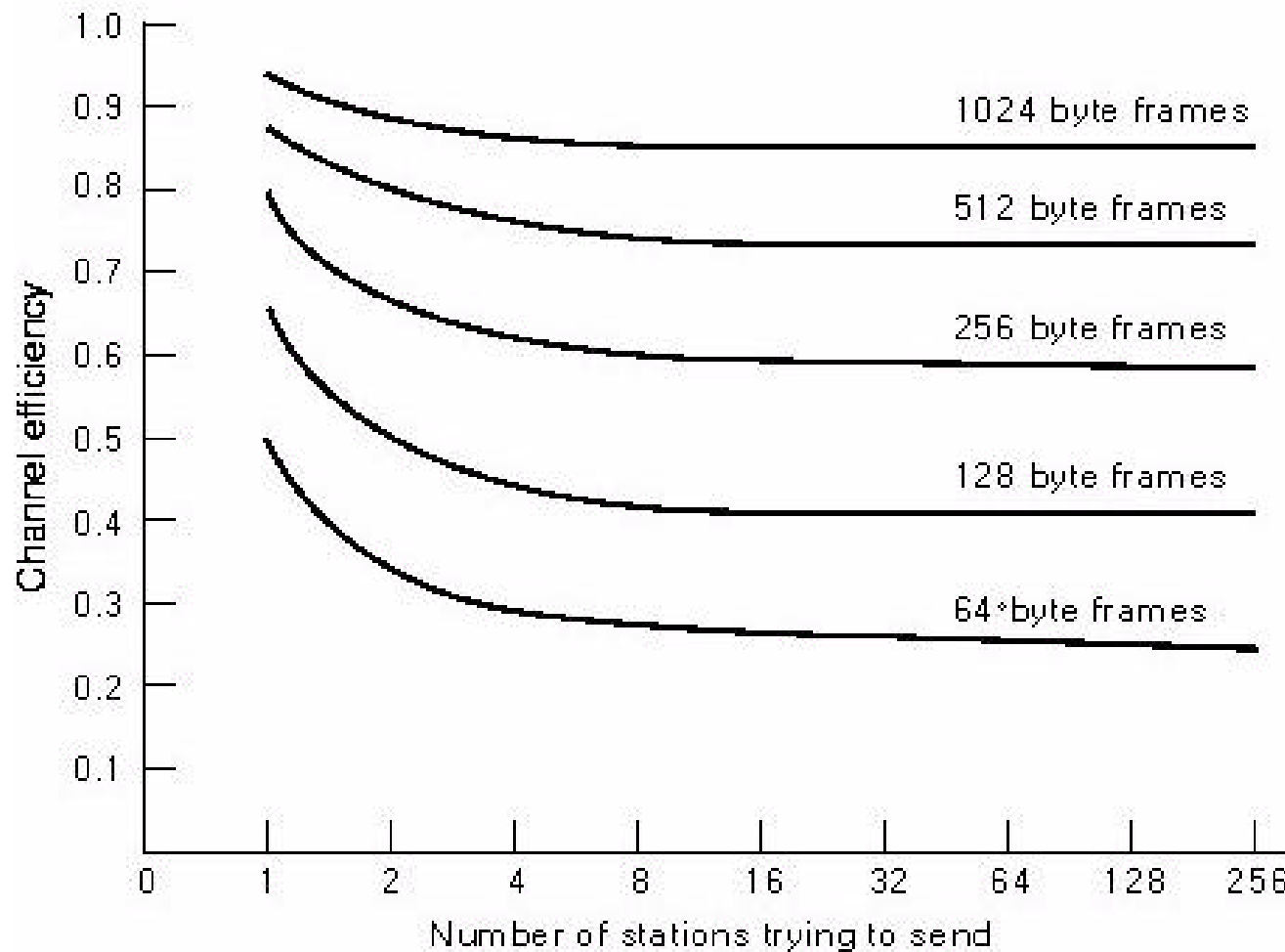

EECC694 - Shaaban

Gigabit Ethernet, IEEE 802.3z

- Standard not fully specified, to be completed in 2000.
- Allows half- and full-duplex operation at speeds of 1000Mbps.
- Uses the 802.3 Ethernet frame format.
- Uses the CSMA/CD access method.
- Addresses backward compatibility with 10BASE-T and 100BASE-T technologies
- Proposed channel types:
 - **1000BASE-SX**: Multimode fiber-optic link, maximum length of 550 meters.
 - **1000BASE-LX**: Single-mode fiber-optic link, maximum length of 3 kilometers.
 - **1000BASE-CX**: Copper-based twisted-pair link with a maximum length of at least 25 meters (to be extended to 100 meters).

An Ethernet-Based LAN Architecture Example

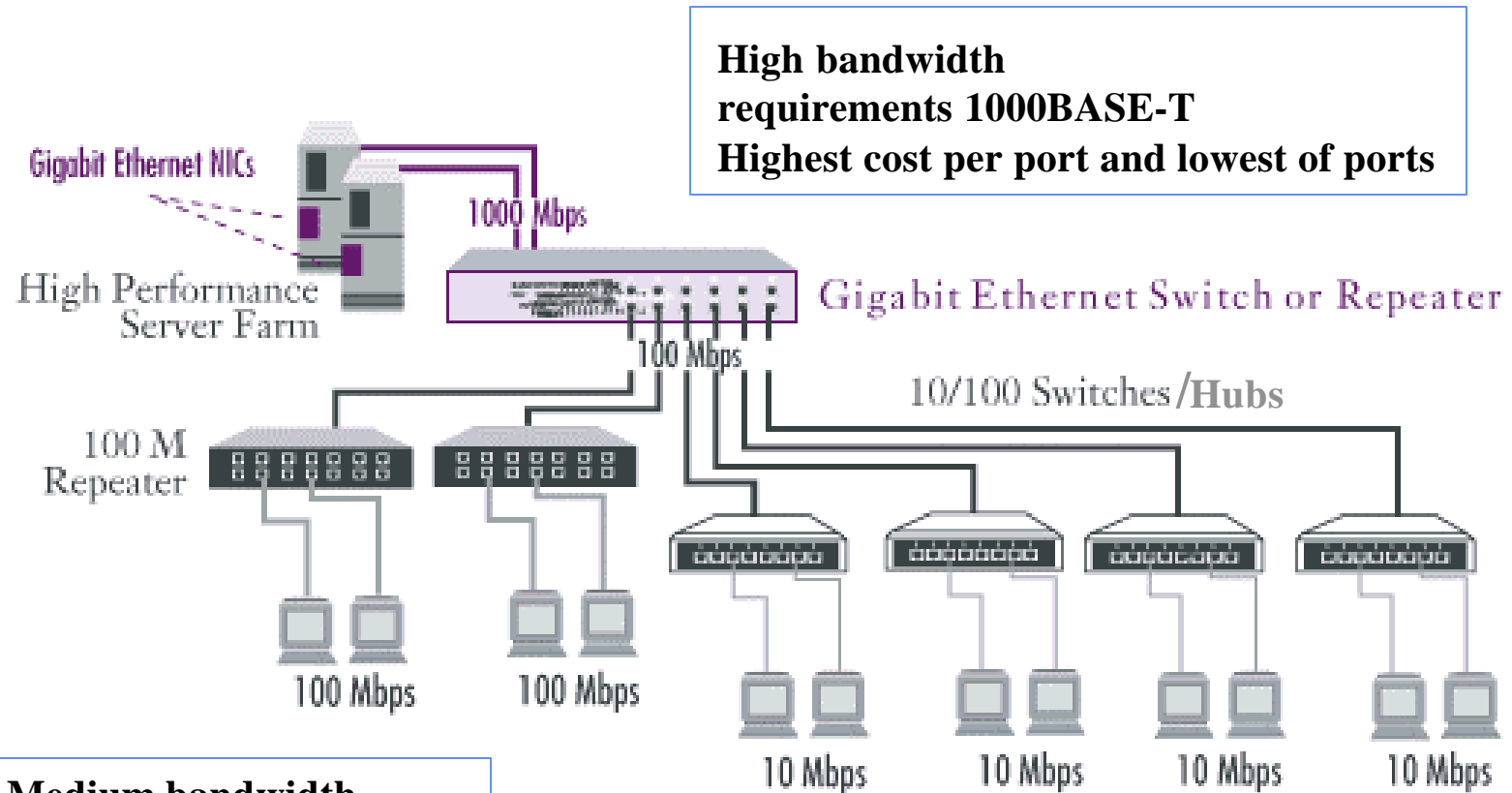

High bandwidth requirements 1000BASE-T
Highest cost per port and lowest of ports

Medium bandwidth requirements 100BASE-T

Low bandwidth requirements 10BASE-T
Lowest cost per port, largest number of ports

IEEE Standard 802.4: Token Bus

- A linear or tree-shaped bus with N stations.
- Stations are organized as a logical ring where each station knows the address of its logical right and left neighbors.
- Only the station in possession of a special control packet “token” is allowed to transmit.
- Once a station is done transmitting it passes the token to one of its two logical neighbors.
- A station in possession of the token and data to transmit passes it on.
- Collision-free protocol; no starvation.

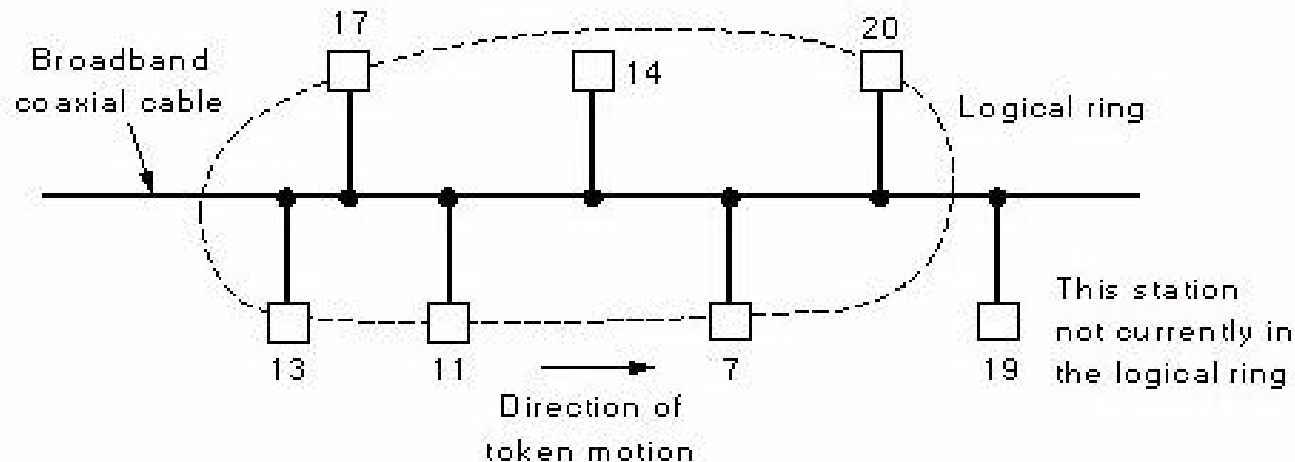

IEEE Standard 802.5: Token Ring

- N stations connected using point-to-point links to form a ring.
- A 3 byte token circulates around the ring
- A station desiring to transmit removes the token from the ring and once it passes by and converts a single bit in the token to 1 indicating the start of a frame.

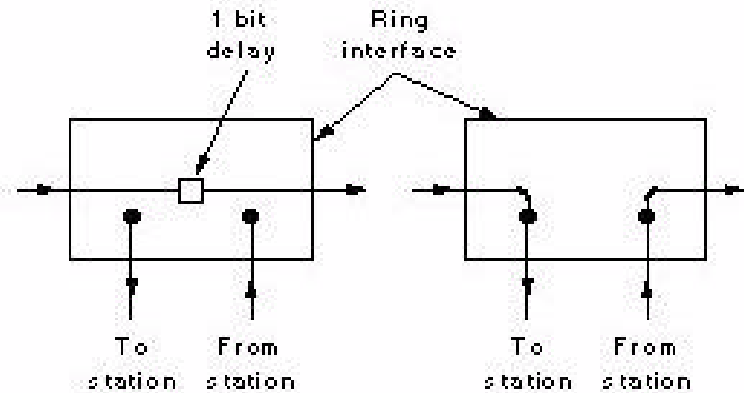
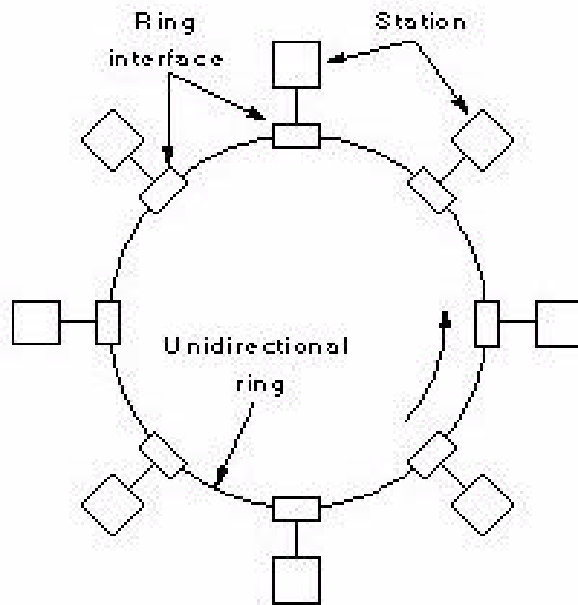

**Listen
Mode**

**Transmit
Mode**

IEEE 802 Frame Formats

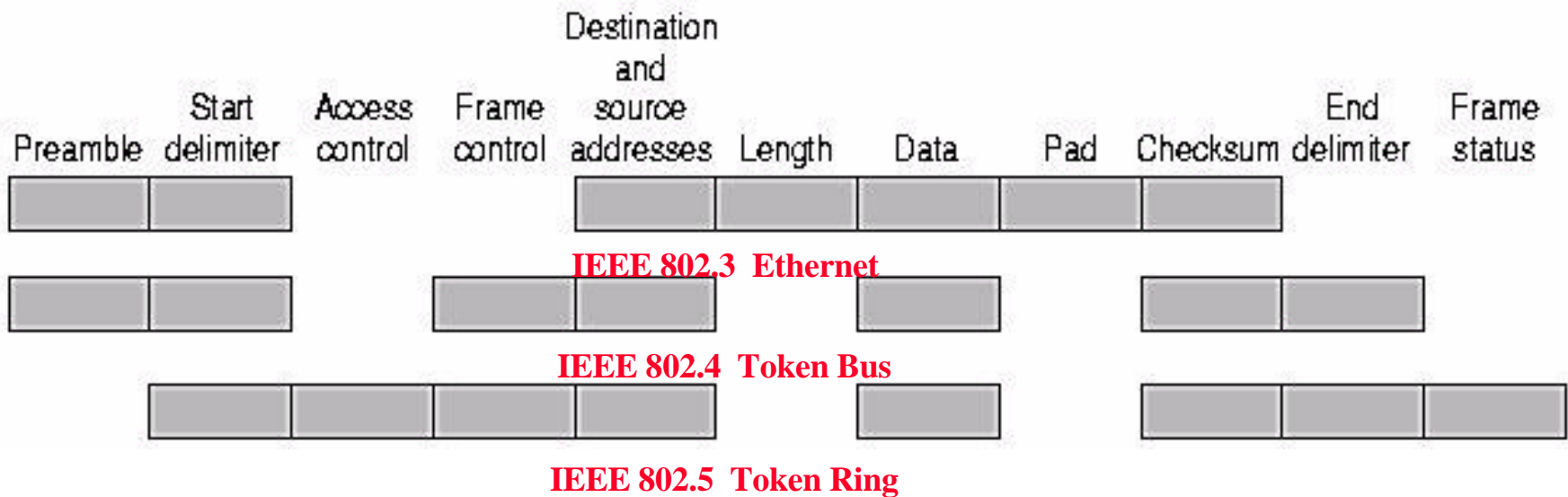

Fiber Distributed Data Interconnect (FDDI)

- FDDI is another ring LAN technology. Transmits data at 100Mbps.
- Uses pairs of fiber optic cables to form two counter-rotating concentric rings in which data flows in opposite directions.
- In case of fiber or station failure, remaining stations loop back and reroute data through spare ring.
- All stations automatically configure loop back by monitoring data ring.

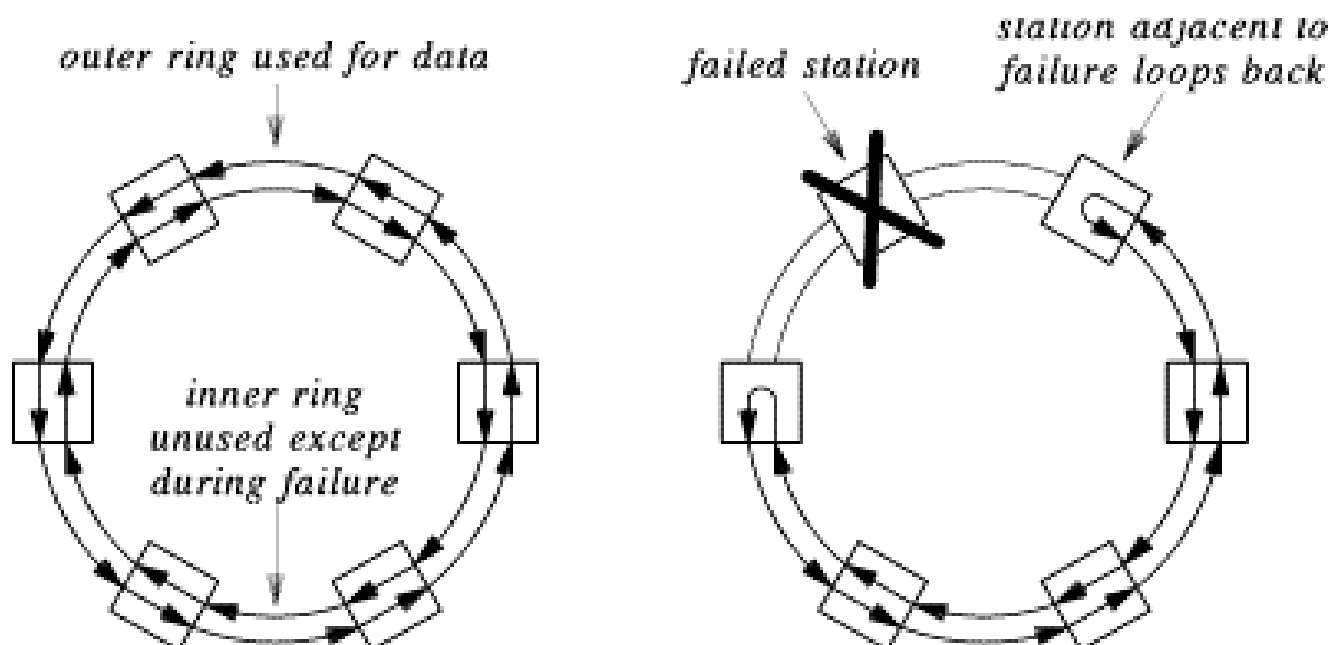

Asynchronous Transfer Mode (ATM) Star Network

- ATM technology consists of ATM cell switches to which computers are connected using fiber optics in a star topology.
- Computers get point-to-point connections - data from transmitter is routed directly through the ATM switch to destination at a data rate 155 Mbps or 622 Mbps.

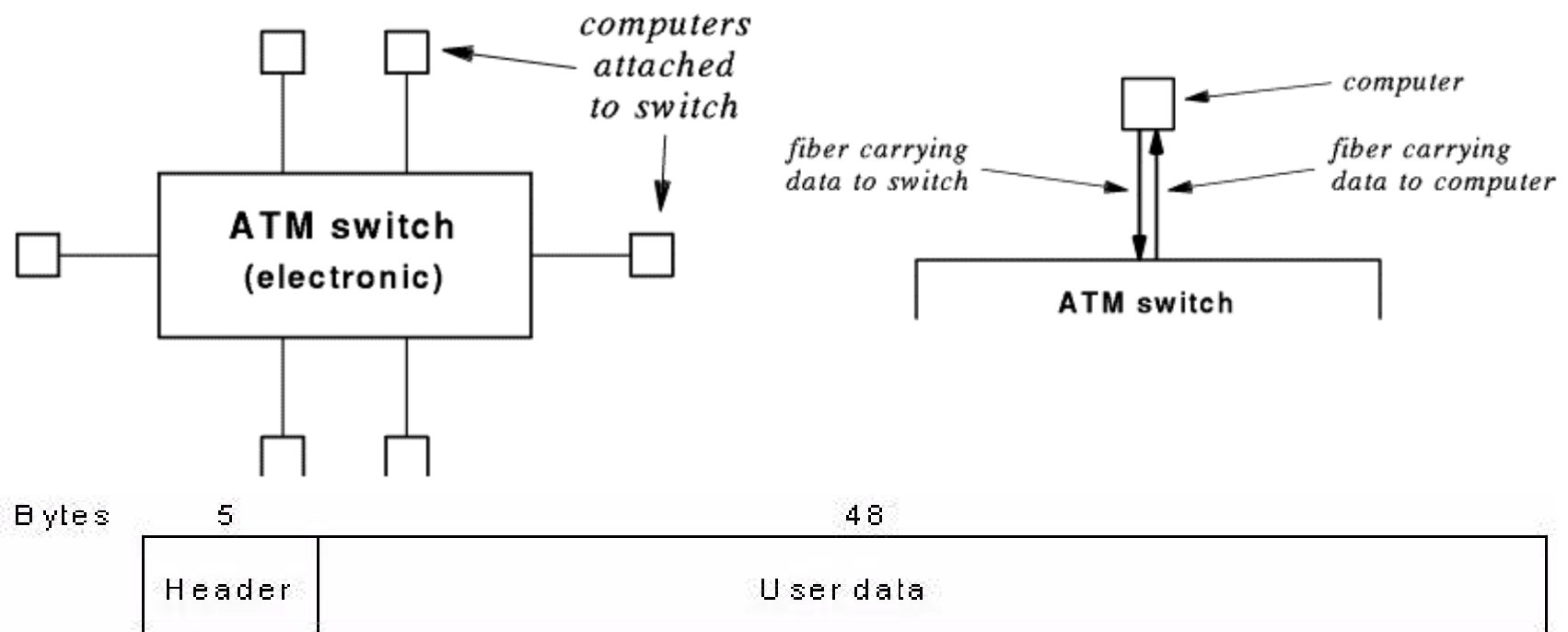

A single ATM cell

ATM-Based LANs

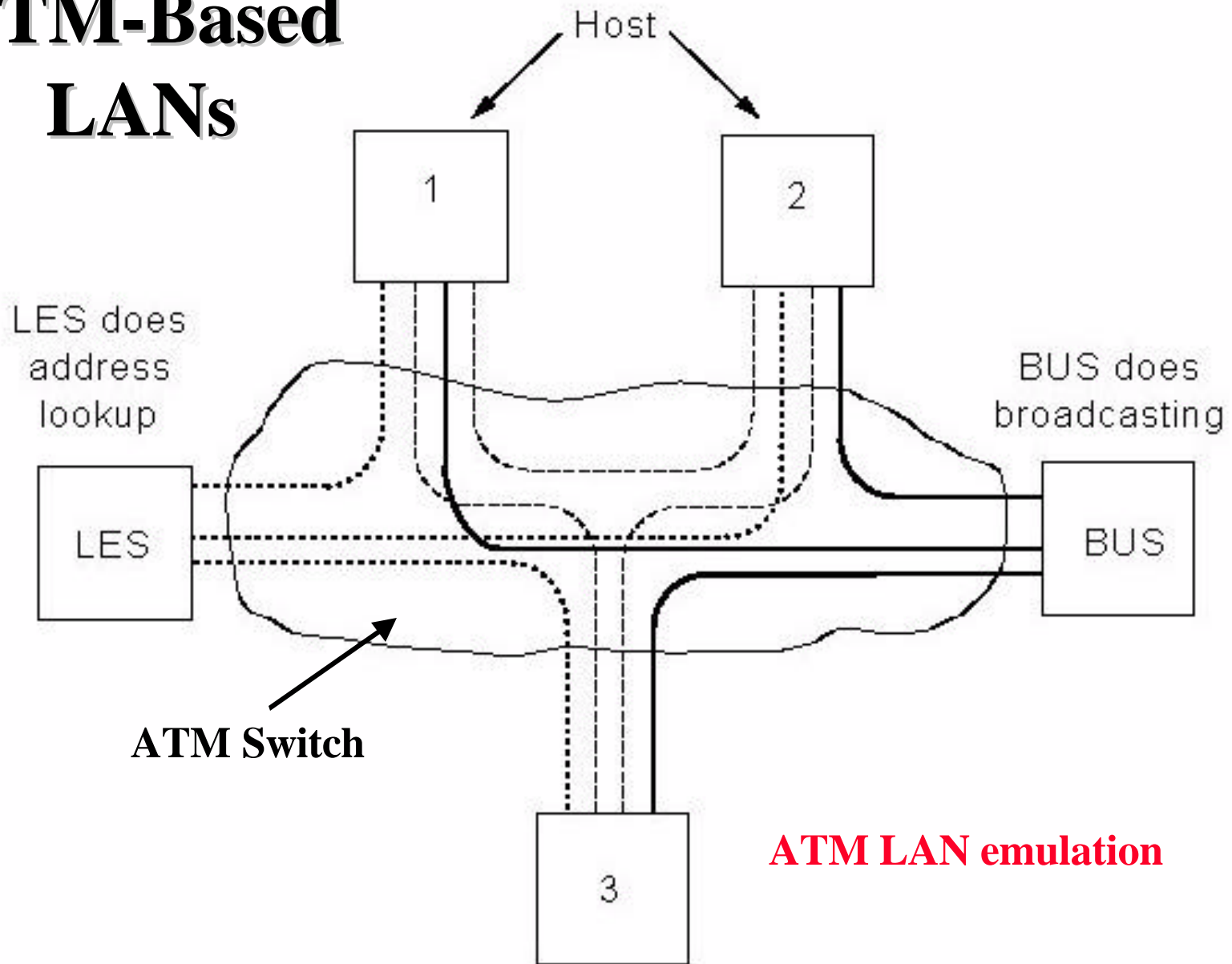

Bridges

Devices used to connect multiple LANs with different protocols or **segments** of a single LAN.

